



Orb Pilot



SYRRIS
Orb Pilot

Product information



Pilot scale modular jacketed reactor offering
multiple setups in one footprint

Orb Pilot

Orb Pilot is a flexible and versatile floor-standing jacketed reactor system for scaling up of batch processes. Designed with the help of scale-up chemists and chemical engineers, Orb Pilot offers a wealth of user-friendly benefits, such as quick vessel changes, easy height adjustments, and a self-adjusting spring-loaded base frame, making it incredibly easy to use.

With 10 to 50 L vessels in a range of profiles, temperature range of -40 to 235 °C, powerful stirrer motors, and a selection of PTFE and stainless steel stirrers, Orb Pilot is easily configured to match your exact requirements. It's this versatility that truly provides multiple reactor setups in one footprint.

syrris.com/orb-pilot



Designed for you

In designing Orb Pilot, we consulted with numerous chemical engineers to ensure we incorporated features that will make your life easier.



Designed to mimic production vessels

Orb Pilot vessels mimic the L/D ratios of production scale vessels for easier scale-up to production. A range of stirrers—including industry-standard hydrofoil—provide various mixing options to suit all needs. Top loaded removable glass baffles provide superior mixing and easy cleaning.



Easy vessel changes and cleaning in under an hour

In other reactor systems, changing and cleaning vessels can take days. Your time is too valuable, so Orb Pilot was designed to enable vessel changes in under an hour. The tool-free clamp holds the vessel in place even when completely undone, enabling in-place vessel cleaning.

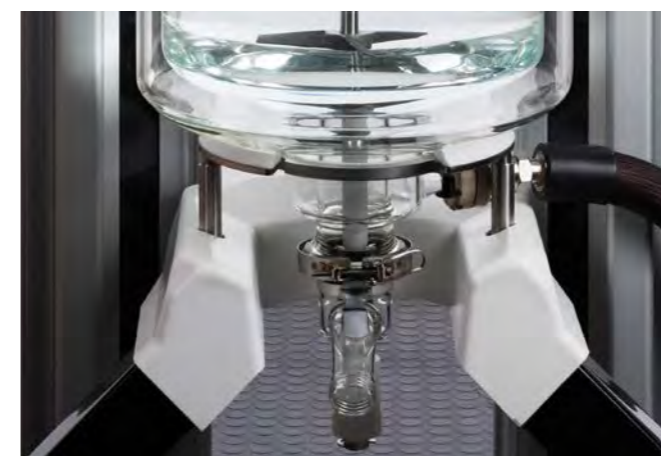

Detachable, spring-loaded BOV

Vessel bottom outlet valves are the most common things to break on a reactor. Orb Pilot's BOV uses a unique spring-loaded design to ensure it can't be overtightened, and is detachable for easy cleaning or replacement in case of accidental damage.

Features

Reflux Kit

The Reflux Kit enables applications at reflux as well as product concentration. Includes a 3500 cm² condenser, condenser support, coupling component, and fittings

Lids

The Orb Pilot Lid is available in two sizes; DN235 and DN300. Both sizes include a DN60 Charging Port, DN60 Condenser Coupling, 2 x B19 & B34 Probe Ports, and 2 x Baffle Ports. Custom lids are also available

Vessel Clamp

Orb Pilot's unique Vessel Clamp uses a force-limited design, preventing vessel breakages from over-tightening

Base Frame

The Orb Pilot Base Frame is the foundation of the system and provides leveling feet, static dissipation, spring-loaded vessel support, and the ability to couple the frame to the Accessory Tower

Removable baffles

Orb Pilot's glass baffles are top-loaded for fast and easy insertion, removal, and cleaning. These provide far superior mixing compared to systems with no baffles. Available in both high and low shear geometries

Detachable outlet valve

Orb Pilot's BOV uses a unique spring-loaded design to ensure it can't be overtightened, and is detachable for easy cleaning or replacement in case of accidental damage

Leveling feet

High-quality leveling feet with secure locking mechanism enable chemists to move Orb Pilot around the lab with ease, maximizing lab space



Stirrer motors

High-specification motors from leading manufacturers offer performance and durability for the most demanding applications.

An innovative stirrer motor lift system allows the stirrer motor to be easily moved into position or out of the way

Easy height adjustment

Pre-set height adjustments on the frame make selecting the right clamp position for each vessel and the stirrer motor easy

Stirrers

Optimize the stirring performance by matching the perfect stirrer to your application. We can supply industry standard stirrers (such as A310 hydrofoil impellers) to mimic production facilities. Custom stirrers are also available

Oil drain and oil pipes

High-performance insulated hoses maximize heating efficiency, while the Oil Drain Unit enables mess-free oil drain of the reactor

Optimized oil inlet

Orb Pilot's unique oil inlet design ensures incoming oil is evenly dispersed around the entire vessel jacket, avoiding the common issue of hot and cold spots

Accessory Tower

The Accessory Tower couples directly to the Base Frame and accepts a wide range of accessories. The tower also doubles as a base for an automated dosing system, ideal for a mount feed vessel and pump shelf

Simple and flexible

Designed with simplicity and flexibility in mind, Orb Pilot combines high performance and excellent value for all your pilot plant scale-up chemistry needs.



Excellent heat control

Orb Pilot vessels have been designed to ensure completely uniform heat distribution, removing issues of hot and cold spots and enabling rapid temperature changes at all times



Wide range of vessels

One Orb Pilot, multiple setups. Orb Pilot allows jacketed reactors (10 L, 20 L, 30 L, and 50 L) and vacuum jacketed reactors (10 L, 20 L, and 30 L) to be utilized on the same frame



Quick vessel changes

Orb Pilot's unique Vessel Clamp, oil drain function, and quick connections allow vessels to be changed and/or cleaned in under an hour—a fraction of the time of most fixed scale-up reactor systems



Optimized mixing

Orb Pilot's removable glass baffles provide optimized stirring performance for your process. The baffles are top-loaded through ports in the lid and sit alongside the stirrer, breaking up the vortex and ensuring the contents are thoroughly agitated



Simple stirrer motor lift

Orb Pilot's innovative stirrer motor lift allows the stirrer motor to simply be uncoupled from the stirrer and lifted using the preset stirrer motor slide



Reagent dosing options

Accurate volumetric dosing up to 200 mL/min using the Atlas XL Syringe Pump, or a full range of dosing options to suit your process needs are available

Efficient mixing

A jacketed reactor system is only as good as its ability to thoroughly and uniformly mix its contents. With increasing scale comes the increased risk of vortex formation during stirring which results in a dramatic loss of stirring efficiency.

To combat this, Orb Pilot offers top-loaded removable glass baffles that break up the vortex, ensuring the reactor contents are thoroughly agitated. Available in high and low shear options, the baffles are easily removed for cleaning or if your chemistry requires more gentle mixing.

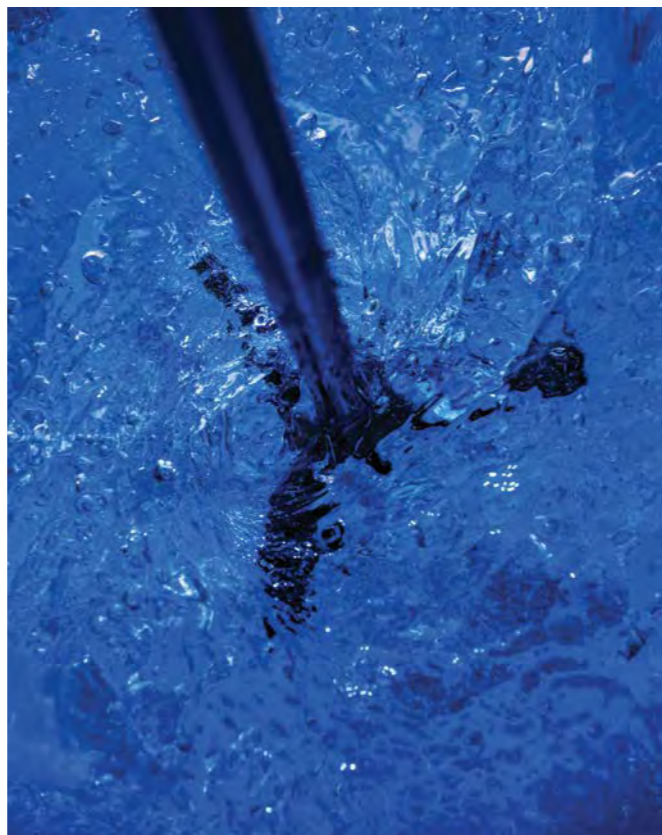

Temperature control

Orb Pilot vessels offer unrivaled thermal performance and are rated to -40 to 235 °C for a wide range of chemistries. The unique centralized oil input design ensures uniform heat distribution over the entire vessel, removing the issue of hot and cold spots throughout your reaction.

Case Study

Improving sustainability in commercial laundry with a custom Orb Pilot system



Robert Bird, R&D Project Manager
Xeros, United Kingdom

Xeros Technology Group—a company specializing in sustainable polymer solutions to advance the commercial laundry industry—can now produce more of their novel XOrb™ beads in one week than they previously could in two years thanks to a custom stirrer and gearbox for their Orb Pilot scale-up reactor.

Syrris' Custom Parts Team worked with Xeros to develop the custom double-helix stirrer and gearbox, specifically designed to fit a 50 L Orb Pilot vessel, to aid research and development of their XOrb beads. Robert Bird, R&D Project Manager, explained:

“One of our missions at Xeros is to improve the sustainability of industrial laundry washing by providing technologies that dramatically reduce water consumption. I work within the Polymer Development Team,

where we have produced novel XOrb™ beads. “These spheroidal balls can be added to a wash load to create a gentle mechanical action, helping to remove dirt and stains using less detergent and at lower temperatures, which saves water and reduces cost.

“In the space of a week, we can now produce more XOrb beads than we could have done in two years without the Orb Pilot system!

“Syrris also helped with the design of a customized stirrer, as well as adaptations to the gearbox and motor of the Orb Pilot, which gave us confidence that the setup would be suitable for our requirements.

“We are extremely happy with our current setup from Syrris and the improved scalability it offers for our XOrb bead production.”





Accessories

Orb Pilot has been designed with the help and feedback from numerous process engineers who understand the issues faced in a scale-up lab. Orb Pilot is easy to customize to your exact requirements; simply choose from a range of vessels sizes and types, baffles, probes, sensors, stirrers, stirrer motors, and other glassware accessories.

Jacketed reactors

Choose from a range of glass jacketed and vacuum jacketed reaction vessels. All Syrris reactor vessels are manufactured at our state-of-the-art glass manufacturing site.

	Jacketed	10 L, 20 L, 30 L, and 50 L
	Vacuum Jacketed	10 L, 20 L, and 30 L
	Custom reactors are also available	

Lids





Orb Pilot lids are available in borosilicate glass and PTFE in DN235 (EU and US) and DN300 (EU and US) sizes. Both sizes include a DN60 Charging Port, DN60 Condenser Coupling, 2 x B19 & B34 Probe Ports, and 2 x Baffle Ports. **Custom lids are also available.**

Probes and Nodes

Wide range of probes and nodes available in various lengths, including temperature, turbidity, and pH.

Stirrers

A wide range of PTFE, glass, stainless steel, and hydrofoil stirrers are available in a variety of geometries.

	Anchor
	Pitch blade turbine
	4-blade propeller
	Custom stirrers are also available







Stirrer motors

High torque (400 N/cm), torque feedback, remote control, and digital display stirrer motors up to 800 rpm are available.

Automation upgrade

Upgrade Orb Pilot to full automation through Atlas PC Software 1, Syrris' powerful and easy-to-use automation platform. Reaction automation enables true walk-away chemistry and offers a number of safety, repeatability, and accuracy benefits to chemists.

Specifications

	Vessel range	10 to 50 L* / 10 to 30 L**
	Temp. range	-40 to 235 °C
	Pressure range	Vacuum: ≤50 mbara. Max. pressure: 250 mbar
	Stirrer motor rpm	500 continuous / 800 intermittent
	Stirrer motor torque	Up to 400 N/cm
	Dosing options	0.005 mL to 200 mL/min (Atlas XL Syringe Pump)

Dimensions

	x (mm)	y (mm)	x2 (mm)	z^ (mm)	z2 (mm)	z3 (mm)
10 L	950	610	1540	1800	1975	1800
10 L VJ / 20 L	950	610	1540	1900	2050	1800
20 L VJ / 30 L	950	610	1540	1950	2115	1800
30 L VJ / 50 L	950	610	1540	2060	2220	1800

	w (mm)	h (mm)	d (mm)
Atlas XL Syringe Pump	355	163	258

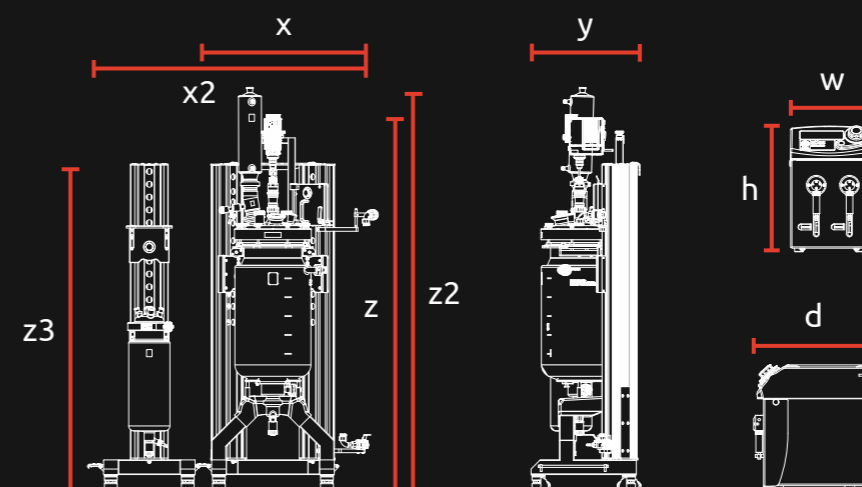

* Jacketed vessels
 ** Vacuum jacketed vessels
 ^ Z dimension requires 80 mm additional height for lifting the motor. The System will run without this height, but to remove the stirrer, lid, and vessel, this additional height is essential.

All dimensions in mm. Please allow a tolerance of +/- 20 mm.

Why choose Syrris?

Custom parts

We understand that all labs are different, so while we've designed our products to be as flexible as possible, sometimes you'll need something unique to your laboratory or application.

Many custom parts are simple variations on existing parts—shorter stirrer shafts or extra ports on a lid, for example. Some customers, however, require far more complex custom parts for their jacketed reactors or flow chemistry systems, such as automated bottom outlet valves (BOVs), unique stirrer designs, or custom vessels.

Syrris' ability to create unique custom parts is one of the main reasons chemists around the world choose Syrris for their needs.

Support

Syrris is on hand to help when you need it. From feasibility studies and proof of concept, through to on-site support by a Syrris engineer, our team are experienced chemists and are supported by a network of trained distributors in over 40 countries.

Built by our UK production team to the highest standard, with chemically resistant materials, Syrris products ensure years of continued service. A 1-year warranty as standard and the option to extend this further for complete peace of mind.

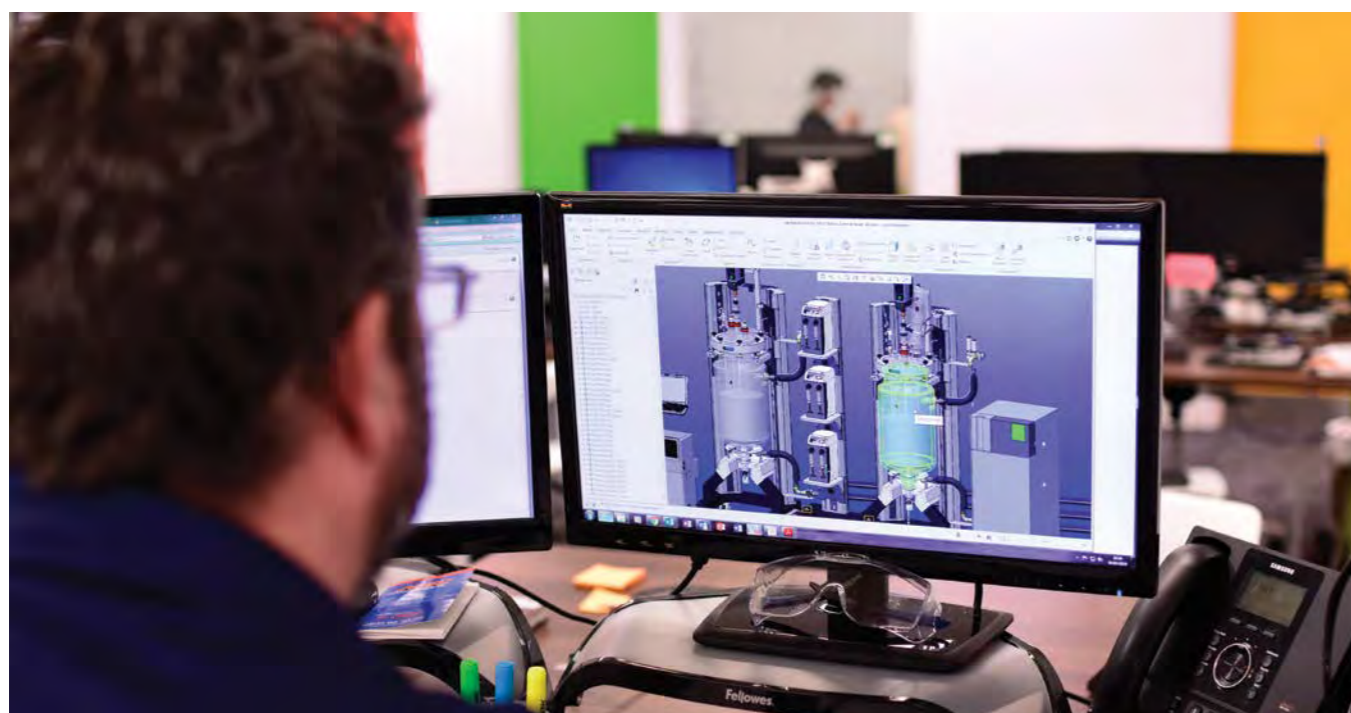

“ In the space of a week, we can now produce more XOrb beads than we could have done in two years without the Orb Pilot system!

**Robert Bird, R&D Project Manager,
Xeros Technology, UK**

“ One key to our success with the system apart from the strength of the product itself is the highly responsive nature of Syrris as a company”

**Dr. Sunil S. Nadkarni, VP, Product
Development Torrent, India**



400

Publications

Syrris products have been cited in over 400 peer-reviewed publications, demonstrating their viability for real-world chemistry

120

Employees

Over 120 employees work on behalf of the Syrris brand and its products, including over 25 qualified Chemists and Chemical Engineers

1000s

of Users

Thousands of chemists and chemical engineers use Syrris products in their ground-breaking research and development, including at the world's top 20 pharmaceutical, chemical, and food and fragrance companies

2

R&D 100 Awards

The Syrris R&D Team have been awarded 2 R&D 100 Awards in recognition of superior product design and innovation

40

Distributors

Syrris works in partnership with over 40 distributors worldwide, offering expert knowledge and local support

5

Global offices

Syrris operates from 5 global offices, spanning the UK, USA, Japan, India, and Vietnam

Get in touch

**UK Head Office (Europe,
S.E. Asia, Australasia,
China, Middle East, Africa)**

t: +44 (0)1763 242555
e: info@syrris.com
w: syrris.com

Japan Office

t: +81 45 263 8211
e: info@syrris.co.jp
w: syrris.co.jp

North America Office

t: +1 (617) 848 1211
e: info-usa@syrris.com
w: syrris.com

India Office

t: +91 22 256 00 262
e: info@syrris.com
w: syrris.com

Hanoi Office

t: +84 (0)24 66553474
e: info@syrris.com
w: syrris.com

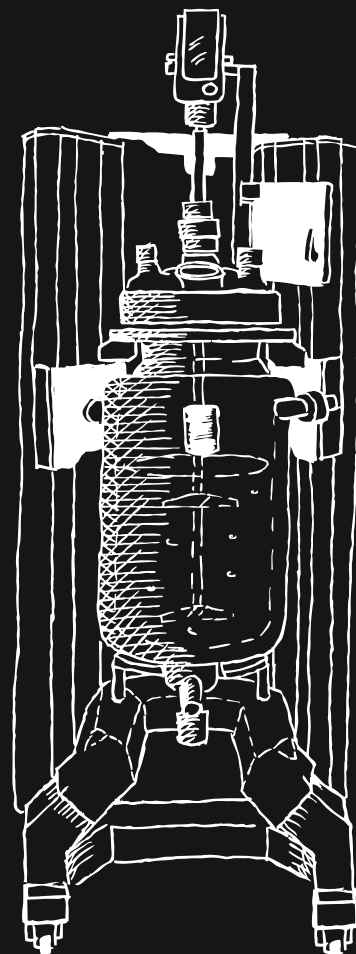

Distributore per l'Italia:

ALFATEST
STRUMENTAZIONE SCIENTIFICA

Contattaci:
alfatest@alfatest.it

alfatest.it
alfatestbio.it
alfatestlab.com